

FAN-CLUB























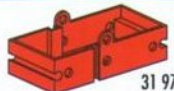

























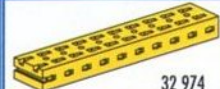













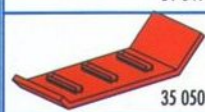

































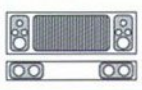

Nr. 27
ZUM SAMMELN

CLUBMODELL:
„Boxentruck“

Auch unsere Rennautos brauchen einen Boxentruck, auf dem sie bequem von einem zum anderen Startplatz transportiert werden können. Der Truck besteht aus unserem Baukasten „Super Trucks“ und dem neuen „Basic Racing“ Baukasten. Damit können die Renner jetzt so richtig an den Haken genommen werden.



Einzelteilübersicht

 31 010	10 x	 31 915	2 x	 32 869	1 x	 35 977	2 x	 37 636	4 x
 31 011	2 x	 31 916	2 x	 32 870	12 x	 35 980	2 x	 38 225	1 x
 31 013	2 x	 31 978	1 x	 32 879	16 x	 35 998	2 x	 38 240	6 x
 31 060	19 x	 31 981	3 x	 32 881	34 x	 36 132	2 x	 38 241	11 x
 31 237	4 x	 31 982	47 x	 32 882	7 x	 36 227	18 x	 38 242	12 x
 31 263	1 x	 31 983	4 x	 32 913	10 x	 36 334	2 x	 38 245	11 x
 31 264	1 x	 31 984	1 x	 32 968	2 x	 36 573	2 x	 38 246	4 x
 31 422	4 x	 31 987	4 x	 32 974	4 x	 36 702	2 x	 38 249	3 x
 31 426	2 x	 31 997	2 x	 35 039	1 x	 36 703	4 x	 38 251	2 x
 31 436	6 x	 31 998	2 x	 31 049	10 x	 36 819	2 x	 38 253	1 x
 31 597	4 x	 31 999	2 x	 35 050	4 x	 36 914	1 x	 38 414	1 x
 31 632	1 x	 32 064	16 x	 35 063	1 x	 36 919	1 x	 38 423	25 x
 31 642	1 x	 32 071	3 x	 35 065	7 x	 36 920	8 x	 38 428	10 x
 31 690	2 x	 32 228	2 x	 35 067	1 x	 36 921	6 x	 38 446	2 x
 31 766	2 x	 32 229	1 x	 35 129	6 x	 36 922	6 x	 38 464	5 x
 31 843	2 x	 32 230	1 x	 35 405	1 x	 36 950	8 x	 38 472	1 x
 31 888	2 x	 32 330	6 x	 35 414	4 x	 37 141	1 x	 78 727	10 x
 31 894	1 x	 32 615	2 x	 35 797	2 x	 37 237	32 x	 104 446	1 x
 31 905	1 x	 32 850	4 x	 35 806	2 x	 37 238	5 x	 113 916	1 x
 31 909	1 x	 32 852	1 x	 35 973	2 x	 37 468	14 x		

Boxentruck

Baustufen für LKW Zugmaschine
siehe Bauanleitung Super Trucks
ab Seite 4

1

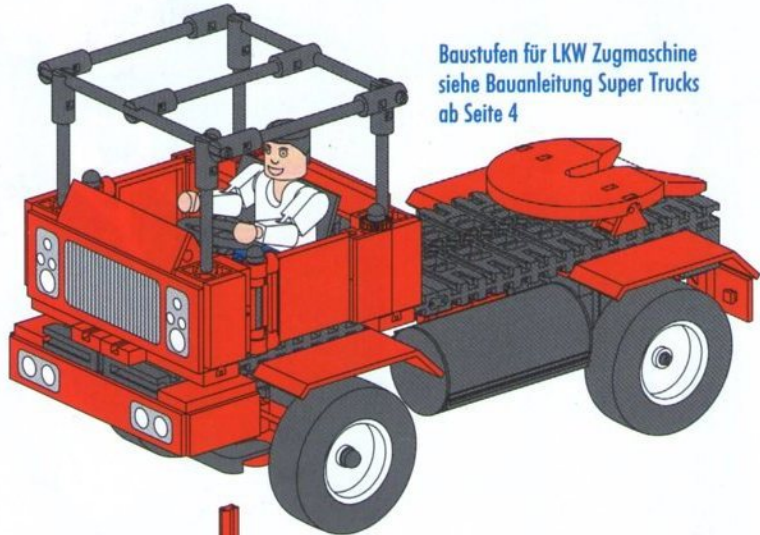

2

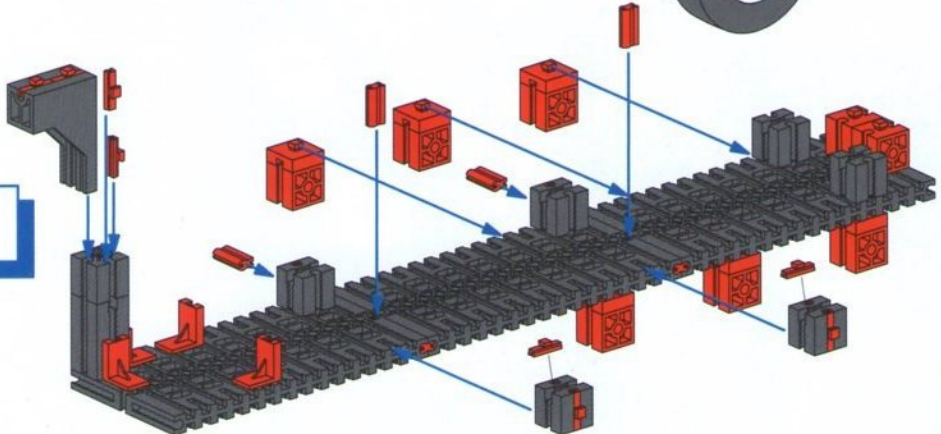

3

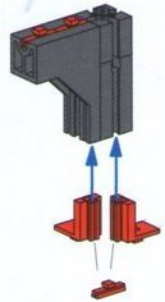

4

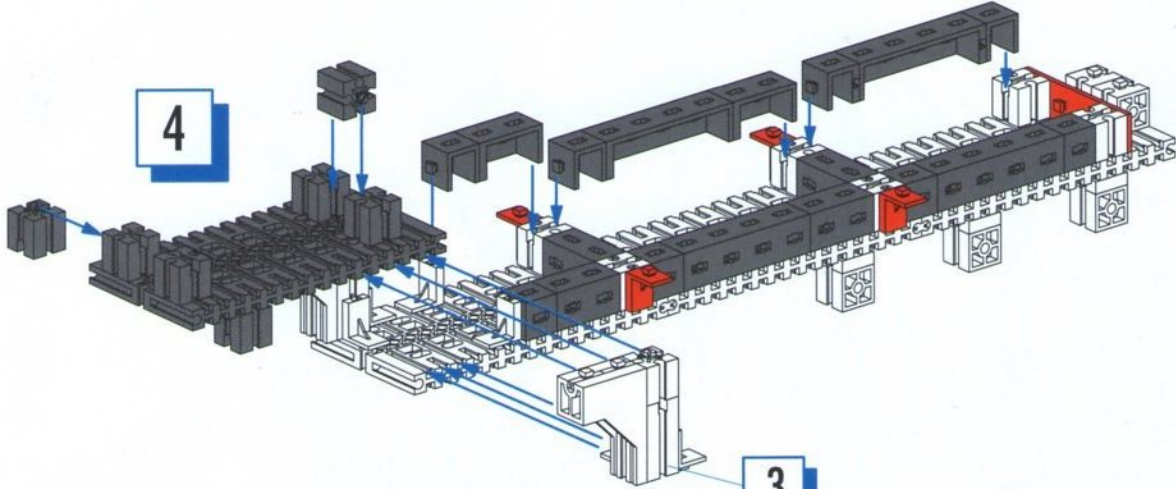

3

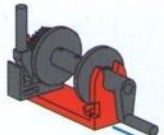

5

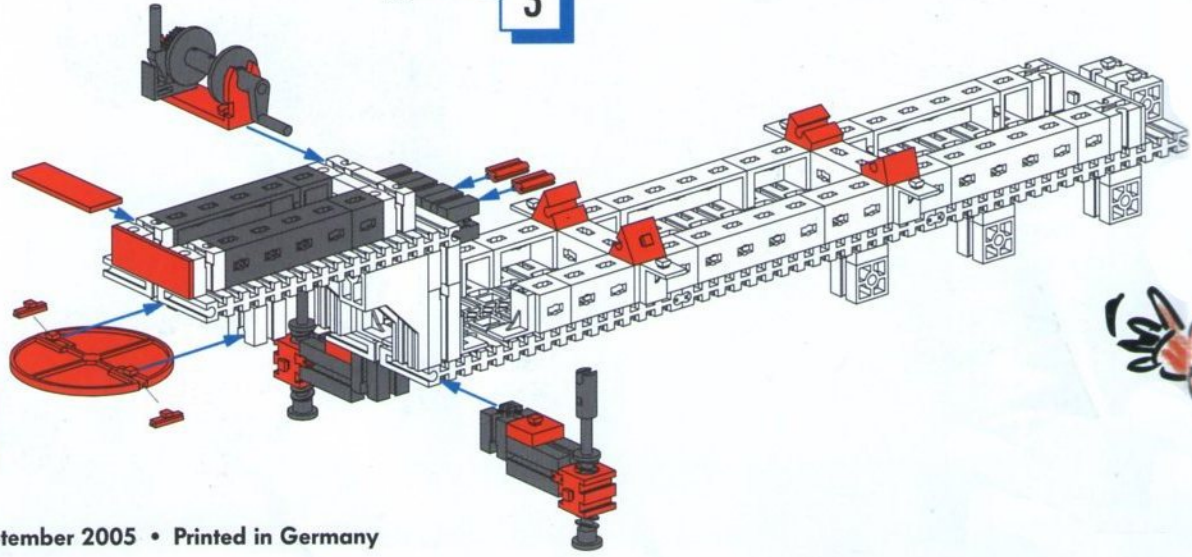

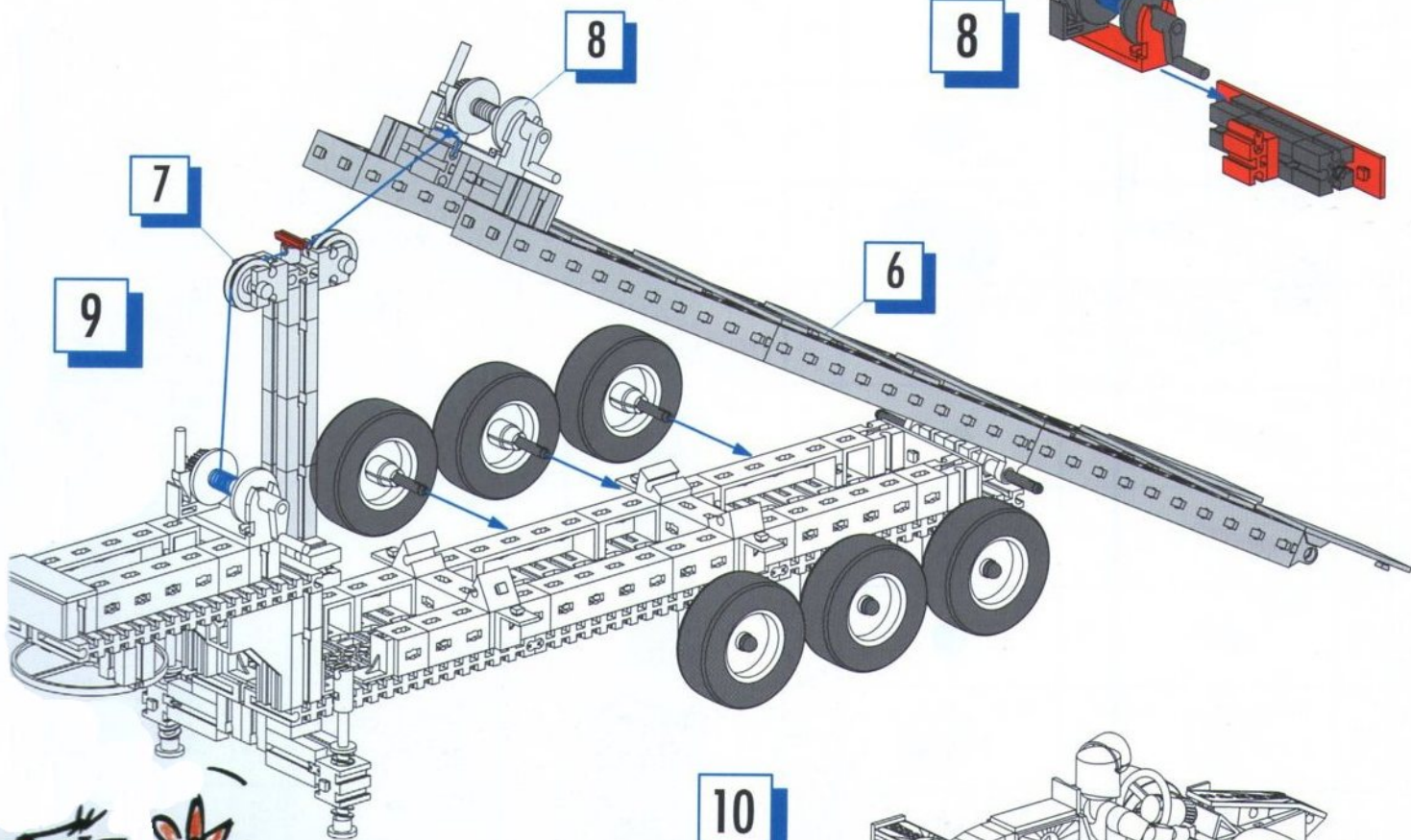
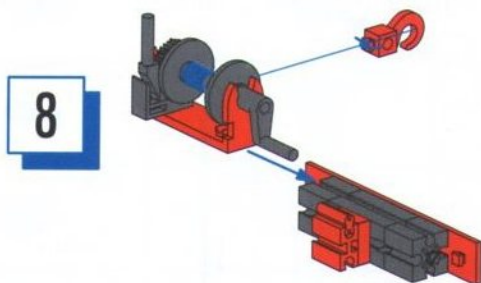
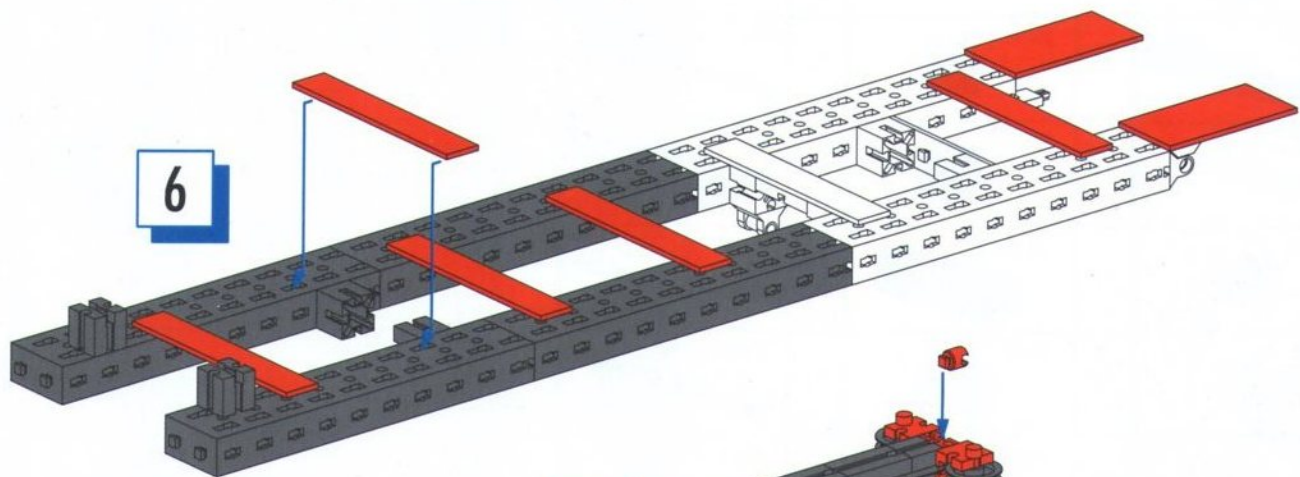
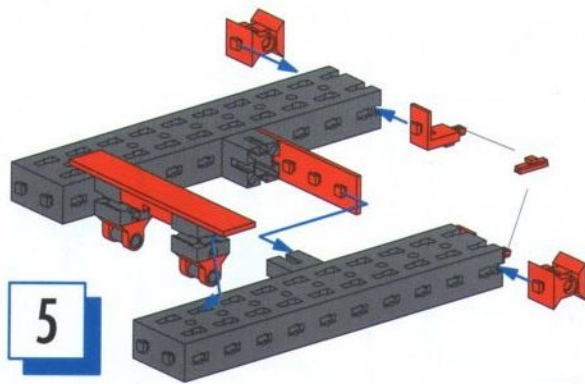

Baustufen für Rennwagen
siehe Bauanleitung Basic Racing
ab Seite 11

